

52274 ✓ ACTIVE



PIDG

TE Internal #: 52274

Ring Terminals & Spade Terminals, Ring Tongue, 16 AWG Wire Size, 1.419 mm² Wire Size, 2800 CMA Wire Size, Stud Size M2.5, PIDG

[View on TE.com >](#)

Terminals & Splices > Ring Terminals & Spade Terminals > PIDG RING TONGUE TERMINALS

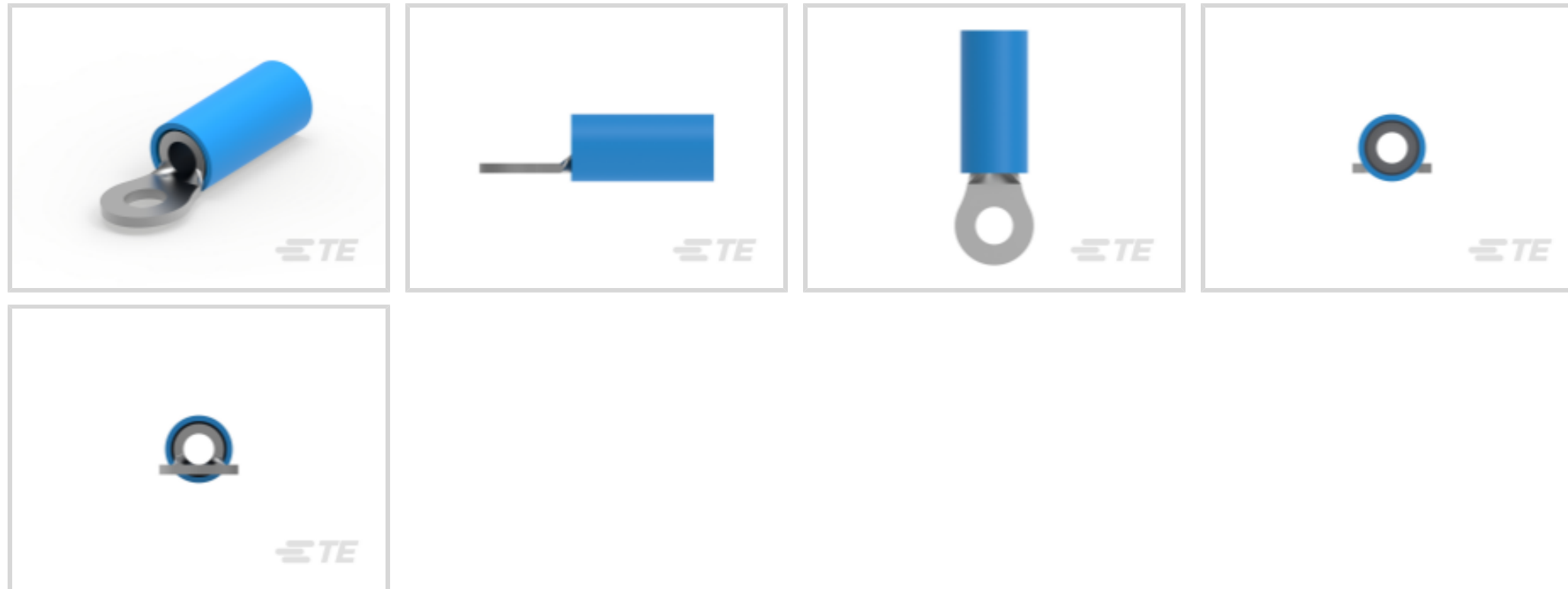

Ring & Spade Terminal Type: **Ring Tongue**

Wire Size: **2800 CMA**

Stud Size: **M2.5**

[All PIDG RING TONGUE TERMINALS \(421\)](#)

Features

Product Type Features

Shape Description	RING-042
Stud Size	M2.5
Sealable	No
Wire Insulation Support Retention Type	Insulation Restriction

Configuration Features

Number of Holes	1
Terminal Angle	180 °

Electrical Characteristics

Voltage (Max)	300 V
---------------	-------

Body Features

Inspection Slot	No
Insulation Sleeve Color	Blue
Stripe Color	Blue

Contact Features



Military Part Class	Class I
Ring & Spade Terminal Type	Ring Tongue
Barrel Type	Closed
Terminal Orientation	Straight
Terminal Plating Material	Tin

Mechanical Attachment

Wire Insulation Support	With
-------------------------	------

Dimensions

Wire Size	2800 CMA
Stud Diameter	2.84 mm[.112 in]
Tongue Thickness	.84 mm[.033 in]
Overall Product Length	19.4 mm[.765 in]
Accepts Wire Insulation Diameter (Max)	3.3 mm[.13 in]
Accepts Wire Insulation Diameter Range	1.6 – 3.3 mm[.063 – .13 in]

Usage Conditions

Insulation Option	Partially Insulated
Operating Temperature Range	105 °C[221 °F]

Operation/Application

Compatible With Wire Base Material	Copper
Compatible With Wire Plating Material	Tin
Heavy Duty	No

Industry Standards

Government Qualified	Yes
----------------------	-----

Packaging Features

Packaging Quantity	500
Packaging Method	Loose Piece

Product Compliance

[For compliance documentation, visit the product page on TE.com>](#)

EU RoHS Directive 2011/65/EU	Compliant
EU ELV Directive 2000/53/EC	Compliant
China RoHS 2 Directive MIIT Order No 32, 2016	No Restricted Materials Above Threshold



EU REACH Regulation (EC) No. 1907/2006

Current ECHA Candidate List: JUNE 2022 (224)

Candidate List Declared Against: JUL 2021 (219)

Does not contain REACH SVHC

Halogen Content

Not Low Halogen - contains Br or Cl > 900 ppm.

Solder Process Capability

Not applicable for solder process capability

Product Compliance Disclaimer

This information is provided based on reasonable inquiry of our suppliers and represents our current actual knowledge based on the information they provided. This information is subject to change. The part numbers that TE has identified as EU RoHS compliant have a maximum concentration of 0.1% by weight in homogenous materials for lead, hexavalent chromium, mercury, PBB, PBDE, DBP, BBP, DEHP, DIBP, and 0.01% for cadmium, or qualify for an exemption to these limits as defined in the Annexes of Directive 2011/65/EU (RoHS2). Finished electrical and electronic equipment products will be CE marked as required by Directive 2011/65/EU. Components may not be CE marked. Additionally, the part numbers that TE has identified as EU ELV compliant have a maximum concentration of 0.1% by weight in homogenous materials for lead, hexavalent chromium, and mercury, and 0.01% for cadmium, or qualify for an exemption to these limits as defined in the Annexes of Directive 2000/53/EC (ELV). Regarding the REACH Regulation, the information TE provides on SVHC in articles for this part number is based on the latest European Chemicals Agency (ECHA) 'Guidance on requirements for substances in articles' posted at this URL: <https://echa.europa.eu/guidance-documents/guidance-on-reach>

Compatible Parts



TE Part # 59170
T-HEAD PIDG SH 26-14 ASSY



REPRESENTATION ONLY

TE Part # 47386
DAHT PG PIDG 26-16 ASSY



TE Part # 58433-3
PRO CR ASSY, RBY IS9252



REPRESENTATION ONLY

TE Part # 47387
DAHT PG PIDG 20-14 ASSY



TE Part # 58423-1
DIE, RBY IS9252



REPRESENTATION ONLY

TE Part # 47387-7
DAHT PG PIDG 16-12 ASSY



REPRESENTATION ONLY

TE Part # 525691
DAHT PG PIDG 16-14 ASSY



TE Part # 2063030-1
SDE DIESET, RBY, UL



TE Part # 47806-2
DIES PIDG 22-16 DIE SET

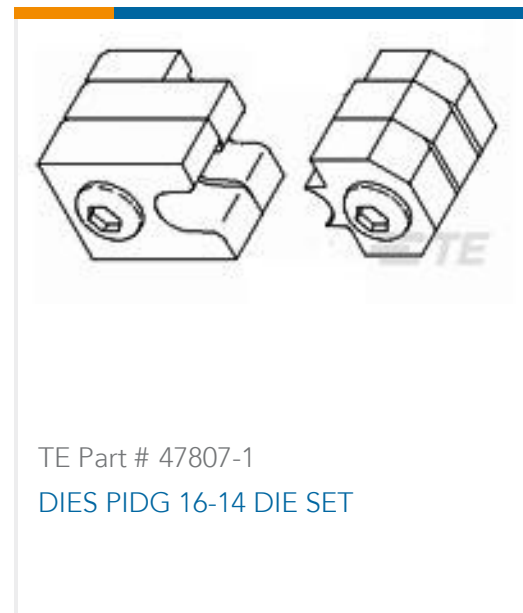

TE Part # 47807-1
DIES PIDG 16-14 DIE SET



TE Part # 169404
CERTI-LOK DIE

Also in the Series | PIDG

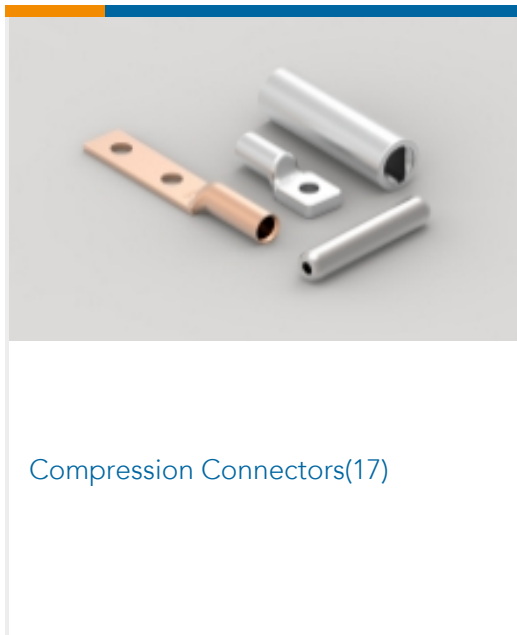

Compression Connectors(17)

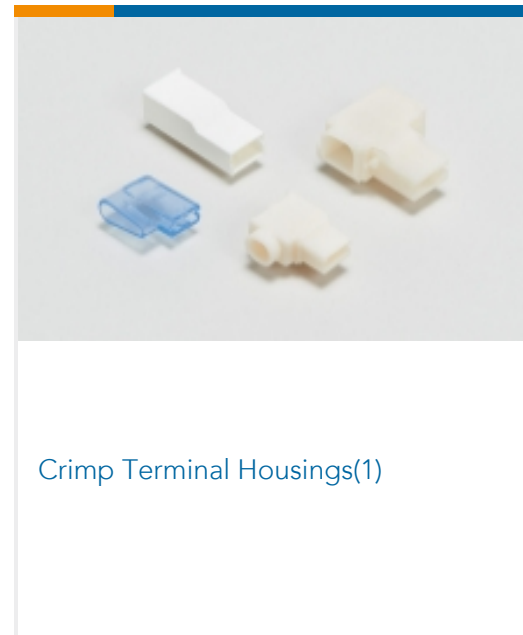

Crimp Terminal Housings(1)



Crimp Wire Pins, Tabs & Ferrules(41)

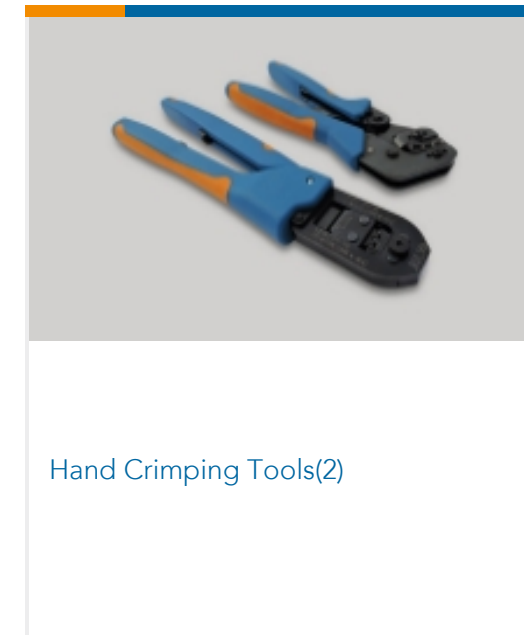

Hand Crimping Tools(2)

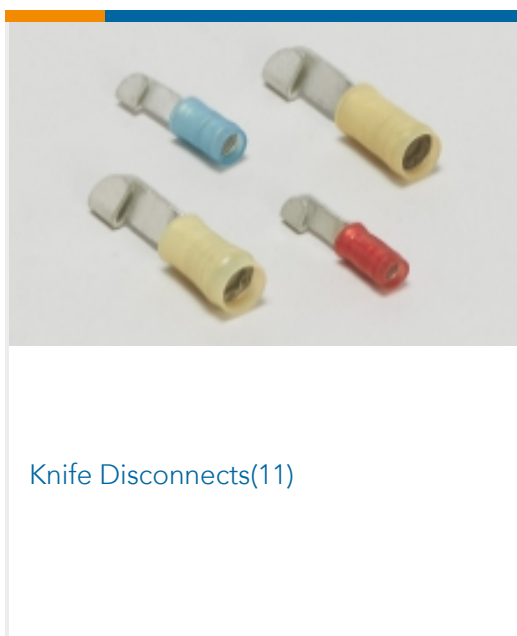

Knife Disconnects(11)

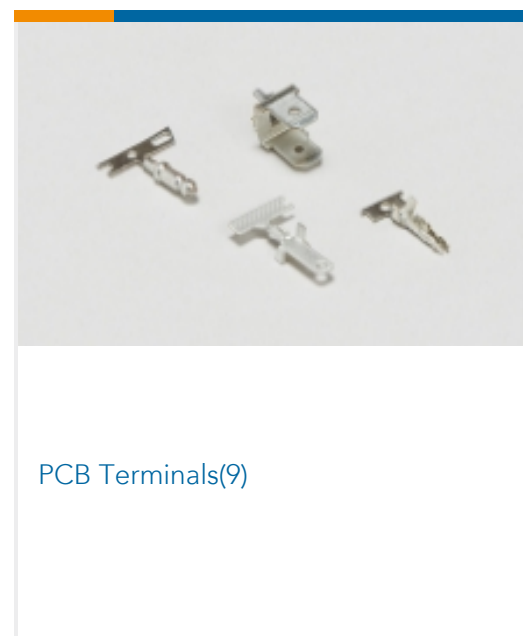

PCB Terminals(9)

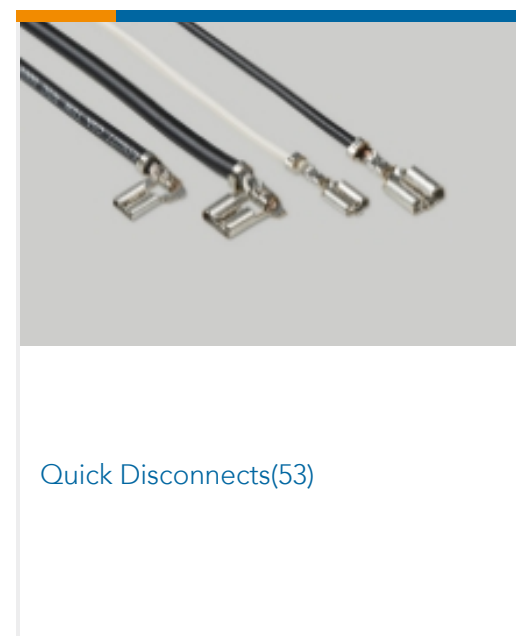

Quick Disconnects(53)

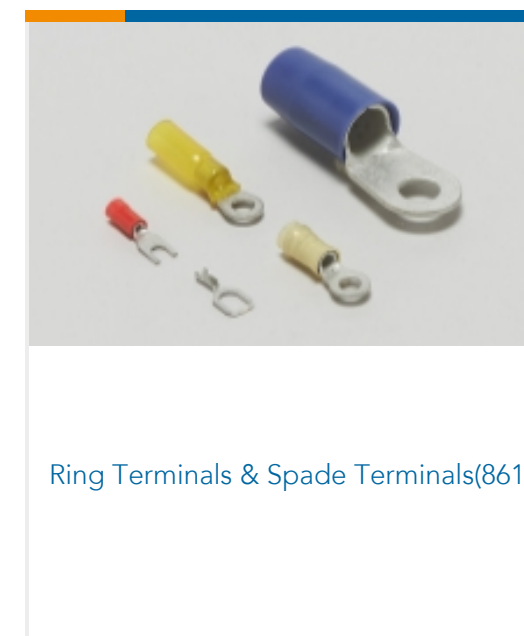

Ring Terminals & Spade Terminals(861)

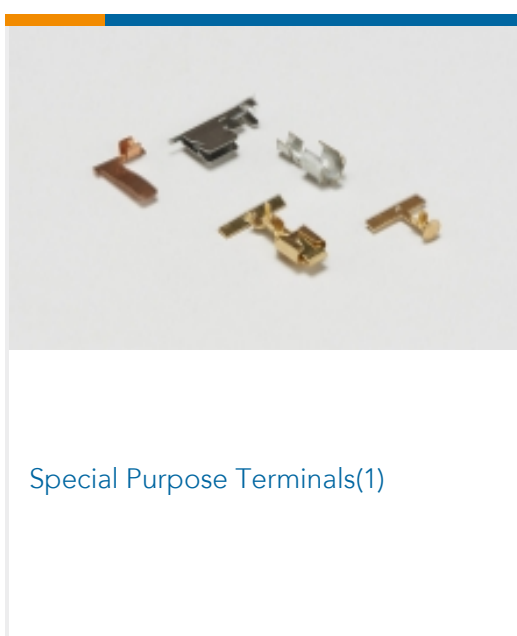

Special Purpose Terminals(1)



Splices(48)

Documents

Product Drawings

TERMINAL,PIDG R IR 16 4

English

CAD Files

3D PDF

3D

Customer View Model



[ENG_CVM_CVM_52274_K.2d_dxf.zip](#)

English

Customer View Model

[ENG_CVM_CVM_52274_K.3d_igs.zip](#)

English

Customer View Model

[ENG_CVM_CVM_52274_K.3d_stp.zip](#)

English

By downloading the CAD file I accept and agree to the [Terms and Conditions](#) of use.

Product Specifications

[Application Specification](#)

English

Product Environmental Compliance

[TE Material Declaration](#)

English

Agency Approvals

[CSA Certificate](#)

English